















**THE NANOSATC-BR, CUBESATS DEVELOPMENT PROGRAM - CAPACITY BUILDING  
WITH THE NANOSATC-BR2'S LAUNCH, FIRST OPERATIONS AND EXPECTED  
RESULTS THROUGH INPE'S GROUND STATION AT SANTA MARIA**

Nelson Jorge Schuch <sup>1</sup>, Rodrigo Passos Marques <sup>2</sup>, Ian Gabriel Souza Lanza <sup>1</sup>,  
Fernando Sobroza Pedroso <sup>1</sup>, Lorenzo Quevedo Mantovani <sup>3</sup>, Marlos Rockenbach da Silva <sup>4</sup>,  
Carlos Leandro Gomes Batista <sup>3</sup>, Danilo Pallamin Almeida <sup>4</sup>, Fátima Mattiello-Francisco <sup>4</sup>,  
Otávio Santos Cupertino Durão <sup>5</sup>, João Baptista dos Santos Martins <sup>6</sup>, Andrei Piccinini Legg <sup>6</sup>,  
André Luís da Silva <sup>6</sup>, Juliano Moro <sup>7</sup>, Eduardo Escobar Bürger <sup>6</sup>

<sup>1</sup> Southern Space Coordination - COESU/INPE-MCTI, in collaboration with the Santa Maria Space Science Laboratory - LACESM/CT-UFSM, Santa Maria, RS, Brazil – E-mails: njschuch@gmail.com, rodrigo\_marques198@hotmail.com, ian.gabriel.lanza@gmail.com, fespedroso.rs@gmail.com

<sup>2</sup>Centre Intégré de Mécanique, Métallurgie et d'Électricité - CIMME, 1100 Rue Ducas, LaSalle, QC H8N 3E6, Quebec, Canada – E-mail: passro1@ggl.csmb.qc.ca

<sup>3</sup>Aeronautics Institute of Technology - ITA, São José dos Campos, SP, Brazil – E-mails: lorenzo.mantovani@gmail.com

<sup>4</sup>National Institute for Space Research - INPE/MCTI, São José dos Campos, SP, Brazil – E-mails: marlos.silva@inpe.br, carlos.batista@inpe.br, danilopallamin@gmail.com, fatima.mattiello@inpe.br

<sup>5</sup>CRON Technology Systems LLC, São José dos Campos, SP, Brazil – E-mail: otavio@cronsistec.com.br

<sup>6</sup>Federal University of Santa Maria - UFSM, Technology Center, Santa Maria, RS, Brazil – E-mails: batista@inf.ufsm.br, andrei.legg@gmail.com, andre.silva@ufsm.br, eduardo.burger@ufsm.br

<sup>7</sup>State Key Laboratory for Space Weather - SKSW, Santa Maria, RS, Brazil – E-mail: juliano.moro@inpe.br

**ABSTRACT.** The INPE-UFSM's NANOSATC-BR CubeSats Development Program started in early 2008. Nowadays, the program has two CubeSats in space: the NANOSATC-BR1 (1U), launched in 2014 and currently in standby mode, and the NANOSATC-BR2 (2U), which was recently launched in March 22, 2021 from the Baikonur Cosmodrome, Kazakhstan. In this article, the launch of NANOSATC-BR2 is presented, alongside with its final tests, initial operations and expected scientific results. Regarding the Capacity

Building, the main objective of the program, this work focuses in the involvement of the Federal University of Santa Maria - UFSM undergraduate students and professionals in the tracking and control of CubeSats through the INPE's Ground Station at Santa Maria, which works as an excellent tool for supporting CubeSat scientific missions from all around the world and also to qualify students to work on the Ground Segment of space missions. The program was supported by the Brazilian Space Agency (AEB) and the Ministry of Science, Technology and Innovation (MCTI).

**Keywords:** CubeSats, capacity building, ground station, nanosatellites, space mission

### INTRODUCTION

The NANOSATC-BR, CubeSat Development Program, consists of a Brazilian INPE-UFSM (National Institute for Space Research - Federal University of Santa Maria) Capacity Building program on space science, engineering and computer sciences for the development of space technologies based on the CubeSat standard, which had the first Brazilian CubeSat: the NANOSATC-BR1 launched in June, 2014. This CubeSat has completed successfully its mission in space, obtaining measurements of the SAMA – South Atlantic Magnetic Anomaly through the usage of the XEN – 1210 magnetometer, as well as validating the resistance of electronic circuits tolerant to space radiation, developed by Santa Maria Design House (SMDH). In this article, the final tests, the launch and first operations of the brand-new CubeSat of the project – the NANOSATC-BR2 satellite, launched in March 22, 2021 are exposed. The expected scientific results using the data from the payloads are also discussed, as well as the challenges that its operation is currently facing in space. The Capacity Building Program focuses on the usage of INPE's Ground Station at Santa Maria (positioned at longitude 53.7083° W, latitude 29.7292° S), State of Rio Grande do Sul (RS) where students and professionals from several Engineering courses (Aerospace, Electrical, Mechanical) learn how to track and control CubeSats in space, obtaining important data from space missions, and also carry out ground station maintenance, automation, staff training and documentation. The support of INPE's Ground Station at Santa Maria for other CubeSat missions are also discussed, as well as possibilities for expanding the functionalities of the Ground Station's antennae in the near future. The program has support from the Brazilian Space Agency (AEB) and from the Ministry of Science, Technology and Innovation-MCTI.

The paper is organized as follows: Section 1 is dedicated to describe the NANOSATC-BR2's launch, institutions involved and other relevant information about its development. Section 2 describes the NANOSATC-BR2's operation, frames received, problems in space and scientific results obtained by the NANOSATC-BR program. Section 3 describes the Capacity Building through INPE's Ground Station at

Santa Maria, with the involvement of students in the program. Section 4 eventually describes the support that the NANOSATC-BR Program may offer to other CubeSat missions, as well as future work related to improving the INPE's Ground Station at Santa Maria.

### **NANOSATC-BR2: Institutions involved, final technical tests and launch on March 22, 2021**

The NANOSATC-BR2 is a 2U CubeSat, (10x10x22.6 cm), with three major objectives: academic and capacity building, scientific mission and technological mission development. The scientific mission is to monitor the Earth's Ionosphere and Magnetic Field. The Ionosphere composition disturbances in the SAMA region over Brazil has severe effects on satellite telecommunications, as well as the precise location with services such as the Global Positioning Systems (GPS) (Schuch et al., 2019a). The payload equipment for the scientific mission are a Langmuir probe that measures plasma temperature, density and electric potential and a XEN-1210 magnetic field sensor based on the Hall effect.

A list of institutions involved with the NANOSATC-BR2 Project, as well as the stakeholders of the mission are described by Figure 1:

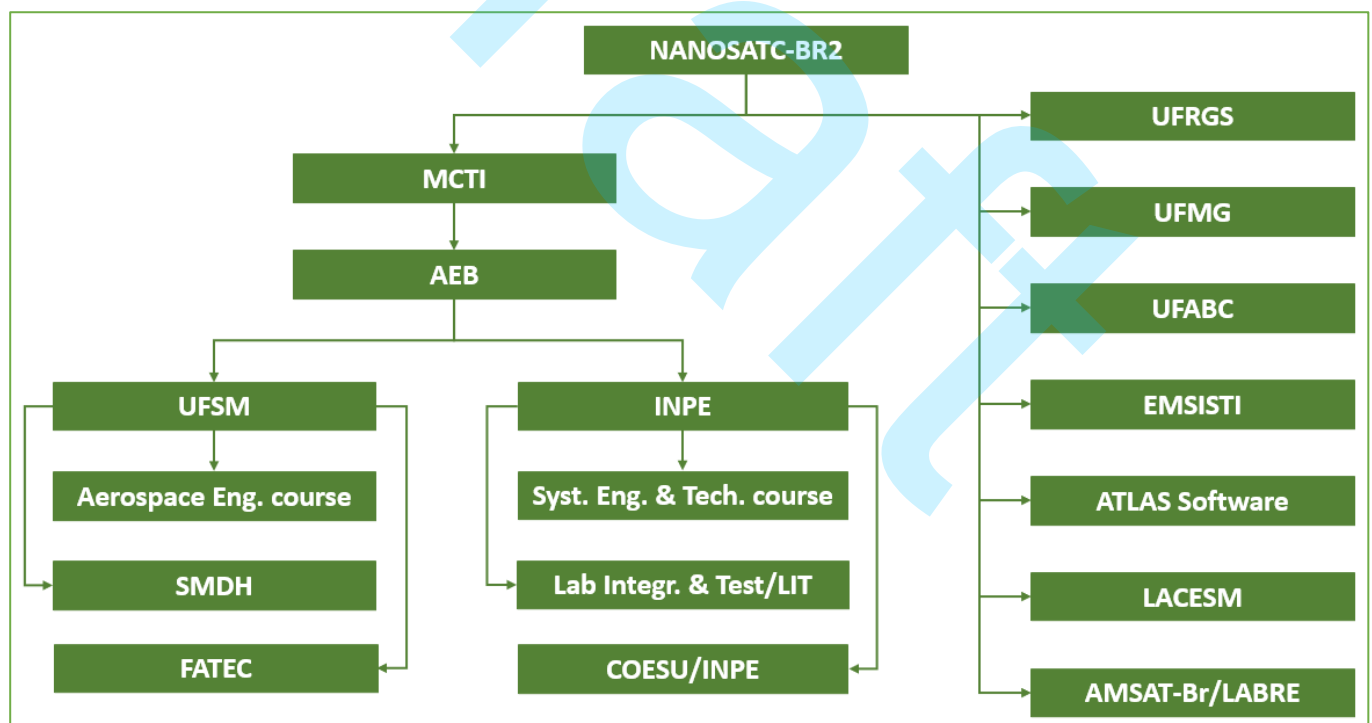

Figure 1: List of the Brazilian institutions and stakeholders of the NANOSATC-BR2's Project.

Acronyms of the Brazilian institutions involved in the Project are: MCTI (Ministry of Science, Technology and Innovation); AEB (Brazilian Space Agency); UFSM (Federal University of Santa Maria); INPE (National Institute for Space Research); SMDH (Santa Maria Design House); FATEC ( Science and Technology Support Foundation); COESU/INPE (Southern Space Coordination of INPE); UFRGS (Federal University of Rio Grande do Sul); UFMG (Federal University of Minas Gerais); UFABC (Federal University of ABC); EMSISTI (Brazilian Startup); ATLAS Software (Brazilian Startup); LACESM (Laboratory of Space Sciences from Santa Maria); AMSAT-Br/LABRE (Brazilian Satellite Radio Amateur community).

Space missions involve complex systems; hence, it is vital to test if the satellite meets its system requirements and is operating according to the designed parameters before the launch. Thus, a complete test campaign was performed. The NANOSATC-BR2 test plan followed the protoflight model philosophy: the tests occur with the satellite flight model using the qualification test levels and the flight test duration (ESA, 2012).

The environmental tests were planned in accordance with the methodology presented by Bürger (2014), and comprises Dynamic Tests, Thermal Vacuum Tests, in addition to required procedures such as Bakeout (to remove undesired gas in the materials), mass and center of mass measurements, and functional tests (NANOSATC-BR Program, 2020). Unlike larger satellites, CubeSats are not required to take electromagnetic compatibility tests since they have a mechanism to prevent its activation while inside the launch vehicle before orbit insertion (Cal Poly, 2014). Figure 2 illustrates the general Assembly, Integration and Test (AIT) sequence adopted; yellow boxes indicate environmental tests and mass proprieties measurements, blue boxes the assembly phases, and green boxes the functional tests. CDS means CubeSat Design Specification (The CubeSat Program, 2014).

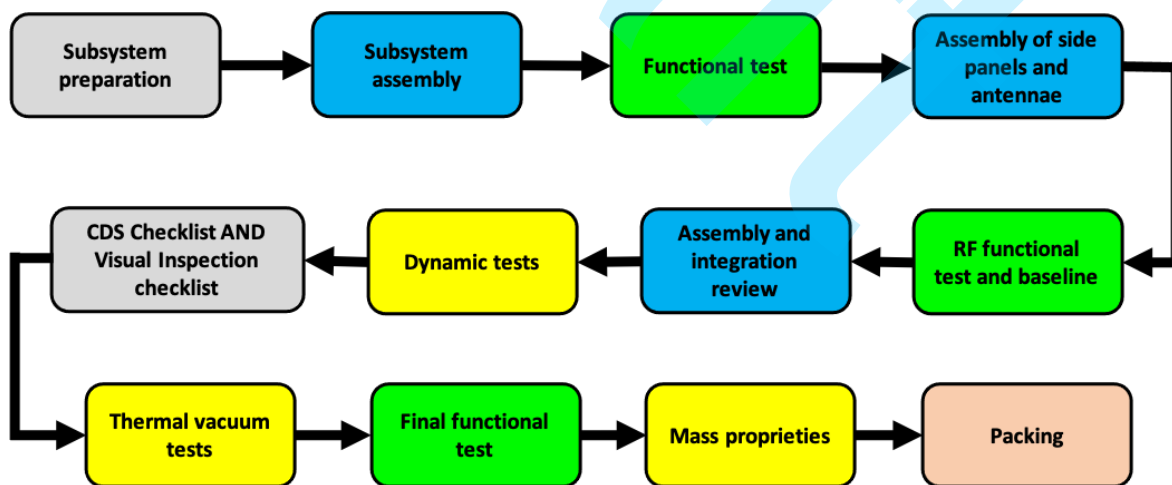

Figure 2: Checklist and General Assembly Integration and Test sequence employed by the NANOSATC-BR2 mission (NANOSATC-BR Program, 2020).

While dynamic tests emulate the launch vehicle environment and ensure the satellite will resist the launch phase, thermal vacuum tests verify if the satellite will manage its temperature correctly once in space, maintaining its subsystems inside the designed temperature range. Functional checks between each test ensure the satellite is operating as expected and, eventually, exposing test failures. Figure 3 presents the environmental tests general sequence with the specific dynamic tests: resonance, sinusoidal test, random vibration test, quasi-static test and shock test; functional tests and inspections are in green squares, while the Packing item describes the preparation for transportation.

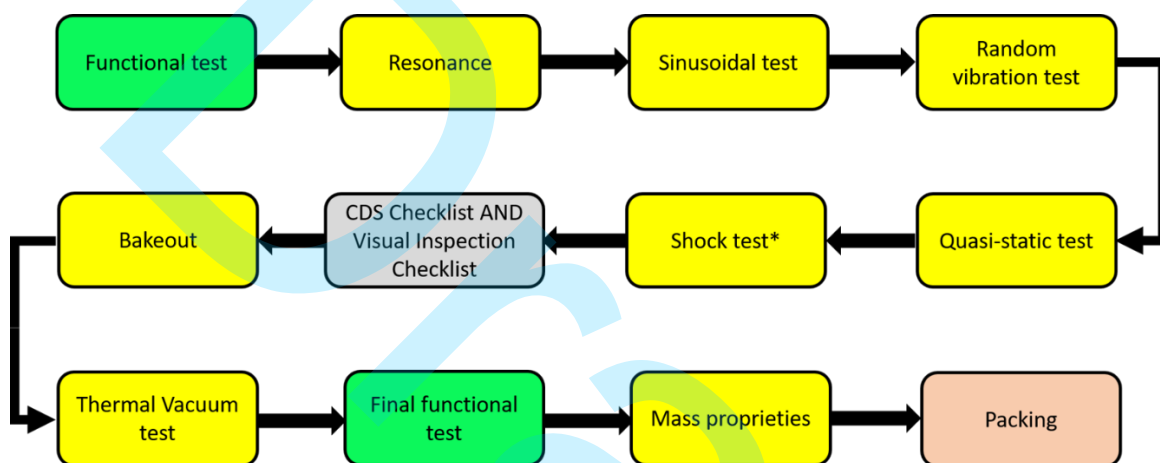

Figure 3: Environmental tests' general sequence; each yellow square comprises a specific detailed test sequence. The asterisk symbol indicates that the test was planned but not performed (NANOSATC-BR Program, 2020).

By the end of 2020, the AIT campaign has been finished at the Integration and Tests Laboratory (LIT/INPE – MCTI), located at INPE's Headquarters in São José dos Campos – SP, Brazil. The CubeSat passed through several tests (Fig.4) during the beginning of December - 2020 (dynamic, thermal, mass properties, etc.), without any non-compliances being detected. The AIT campaign had the active participation of students and professors from the postgraduate course at INPE in Space Systems Engineering and Technology (PG-ETE), and also the technical support and expertise of the LIT/INPE team. The assembling and functional testing were performed to meet the operation scenarios in compliance with the mission concept of operation (Almeida, 2021). The integrated and tested Flight Model (Fig.5) was then ready to be packed and sent for the launch site, in Baikonur - Kazakhstan.

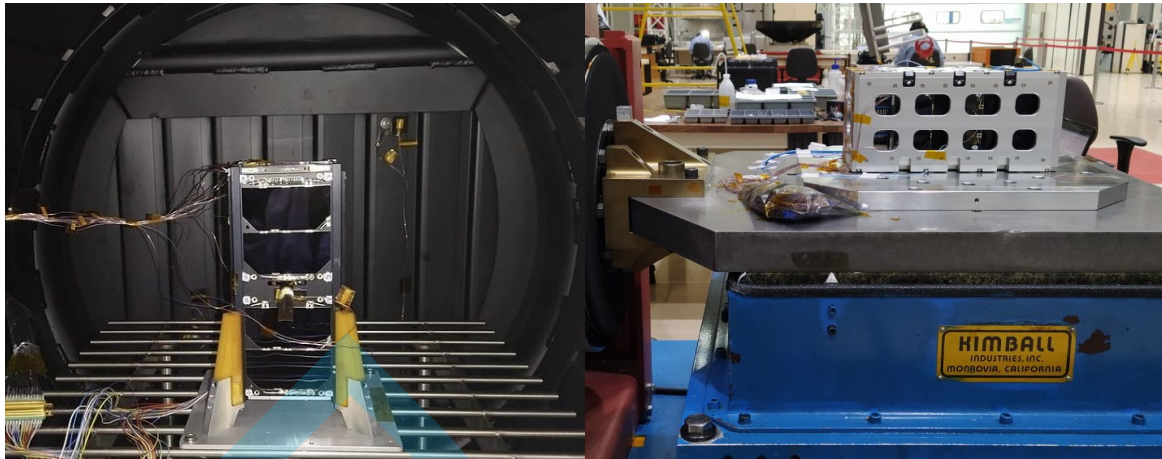

Figure 4: The NANOSATC-BR2 mounted with several internal and external thermocouples inside the Thermal Vacuum Chamber (left), and the CubeSat placed inside a Test-POD on a shaker at the Integration and Tests Laboratory – LIT / INPE - MCTI (right) (Asencio, 2021).



Figure 5: The integrated and tested NANOSATC-BR2's Flight Model ready to be packed and transported, at the Integration and Tests Laboratory – LIT/INPE – MCTI on December, 2020.

On March 22, 2021 the NANOSATC-BR2 was ready to be launched by a Soyuz-2.1a/Fregat vehicle (Fig.6), operated by the company GK Launch Services, from Baikonur Cosmodrome, Kazakhstan. For this specific launch event, 38 satellites from 18 countries were sent to space, being the NANOSATC-BR2 one of the CubeSats launched as a piggyback payload.





Figure 6: The Soyuz-2.1a/Fregat launch vehicle, carrying the NANOSATC-BR2 satellite and lifting off from the Baikonur Cosmodrome, Kazakhstan on March 22, 2021 (GK Launch Services, 2021).

### **The NANOSATC-BR2: First Operations, Frames Received and Current Problems in Space**

Since the NANOSATC-BR2's launch, several radio amateurs from all around the world are collecting and forwarding frames from the satellite, confirming its initial operation in space. The INPE's Ground Station at Santa Maria also received several beacons and frames during NANOSATC-BR2's passages over South of Brazil (Fig. 7), contributing for the LEOP – Launch and Early Orbit Phase, one of the most critical phases of a space mission.

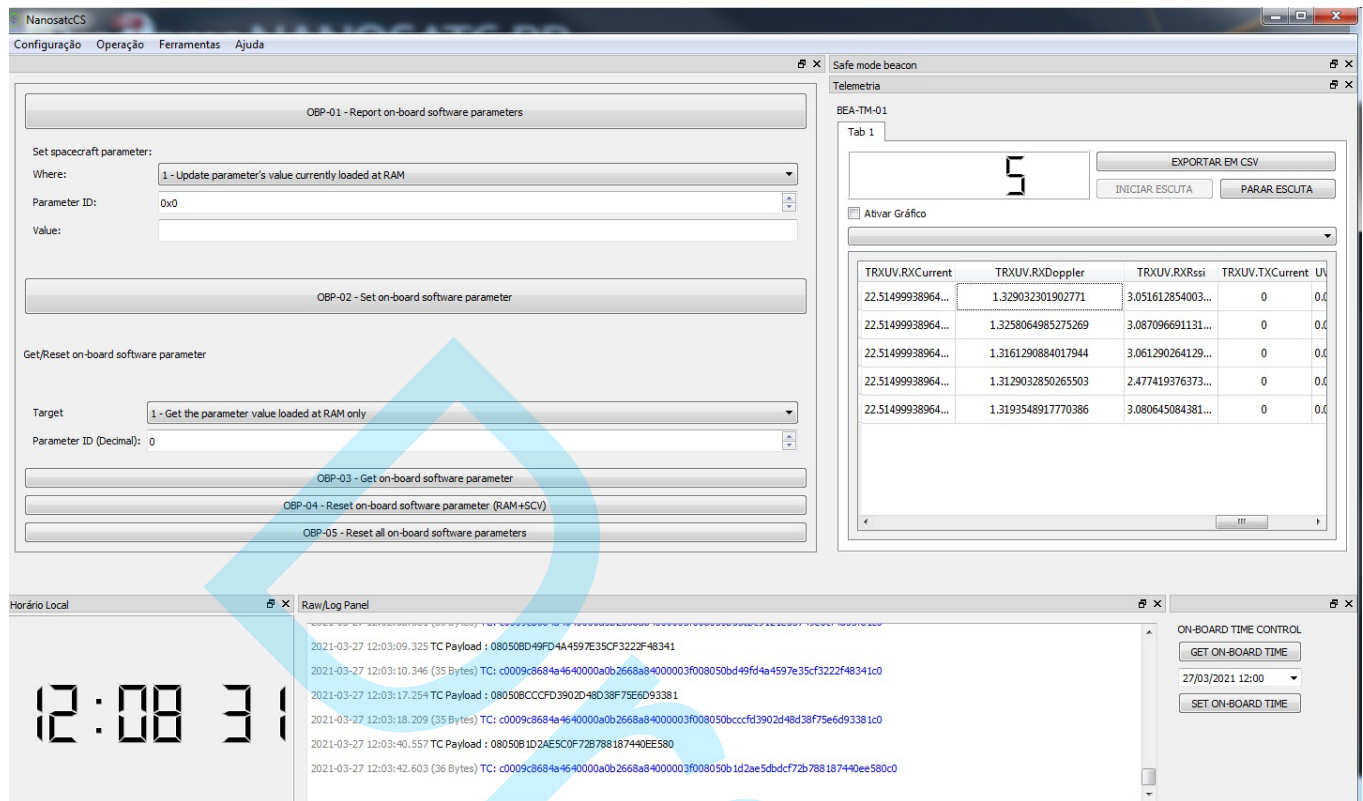

Figure 7: Safe Mode Beacon (5 Frames) received during a passage over the city of Santa Maria – RS, throughout the very first week of the NANOSATC-BR2's flight.

Regarding the expected scientific results, the NANOSATC-BR2 may expand the measurements of the terrestrial magnetic field made by its predecessor, the NANOSATC-BR1, throughout its entire orbit at 600km altitude, using the XEN-1210 magnetometer. By doing so, the NANOSATC-BR2 will complement and confirm the studies made with Brazilian data of the magnetic field at SAMA region, such as the one made by Heirtzler (2002).

The NANOSATC-BR2 may also use data from two different instruments working simultaneously in space, by identifying Ultra-Low Frequency (ULF) pulses in the geomagnetic field and also making the magnetometer work in conjunction with the measurements obtained by the Langmuir Probe.

In the first mission of the program, the NANOSATC-BR1 data were collected by the Scientific Mission Payload, which was a XEN-1210 magnetometer as well. The observations showed an excellent correlation with the theoretical figures for the geomagnetic field intensity, given by the International Geomagnetic Reference Field model (IGRF-IAGA/IUGG) in the same altitude (Schuch et al., 2019a). The same good correlation is also expected in this new NANOSATC-BR2 mission. A map of the total intensity of the geomagnetic field for an altitude at 614 km over South America, in the domain of SAMA (Heirtzler, 2002), is presented in Figure 8.



The intensity of the geomagnetic field changes from 24.000 nT outside the SAMA to 17.000 around the center of this anomaly, signalized by a black star in Figure 8. The INPE's Ground Station at Santa Maria, GS (INPE-COESU), is inside the region of SAMA with larger decrease. The colored line in Figure 8 indicates the approximate orbit of the NANOSATC-BR1 on August 17, 2014, from 10:57h to 11:07h. During this period, the NANOSATC-BR1 moved from South Pole towards to the geographic North Pole.

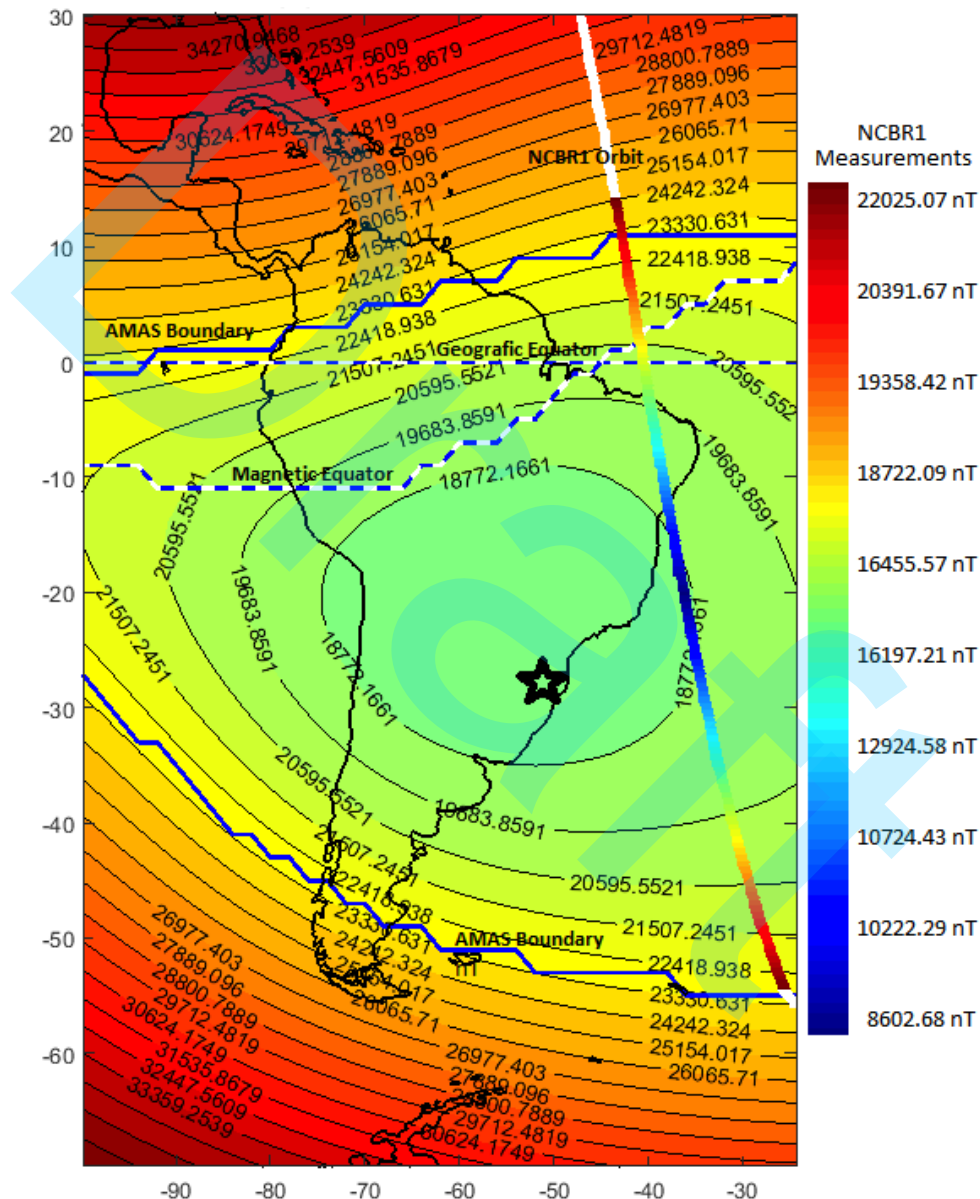

Figure 8: Geomagnetic field total intensity according to the IGRF showing the SAMA and NANOSATC-BR1 Scientific mission payload measurements at 614 km altitude in 2014 for the Geomagnetic Field. The black star indicates the location of the INPE's Ground Station at Santa Maria - GS(INPE-COESU), which is located near the center of the SAMA (Schuch et al., 2019a).

When it comes to technological results, the first mission of the program had electronic circuits for space applications developed by the company Santa Maria Design House (SMDH), with the objective of technology demonstration connecting payloads and the satellite's service module in an environment subjected to Single Event Effect (SEE) (INPE, 2018; Schuch et al., 2019a). Also, the first mission had a Field Programmable Gate Array (FPGA) developed by UFRGS to test fault tolerant software against radiation (Schuch et al., 2019b). For the second mission of the program, a new electronic circuit was developed by SMDH as well, with greater resistance to space events, such as the SEE.

Application Specific Integrated Circuit (ASIC) was developed as one of the technological payloads of the NANOSATC-BR1 Project. The radiation hardened digital cells designed by SMDH proved a tolerance to solar energetic particles with energies of up to 100 MeV (Schuch et al., 2019a).

The SEE tolerance of two shift-registers, with 256 stages and 8 inverters between each chain, is shown in Figure 9. The blue bars correspond to the shift-registers designed using the conventional digital cells provided by the foundry. The red bars represent the radiation hardened digital cells designed by SMDH. It should be mentioned that radiation hardened cells designed by the Brazilian Design House proved tolerance to SEE with X-rays events of severity R1 and R2 (Noval et al., 2016). In relation to the R3 event, the designed cells reported some errors by SEE (Noval et al., 2016). The number of errors in the shift-registers designed using the standard cell library is comparatively larger than the shift registers using rad-hard cell library.

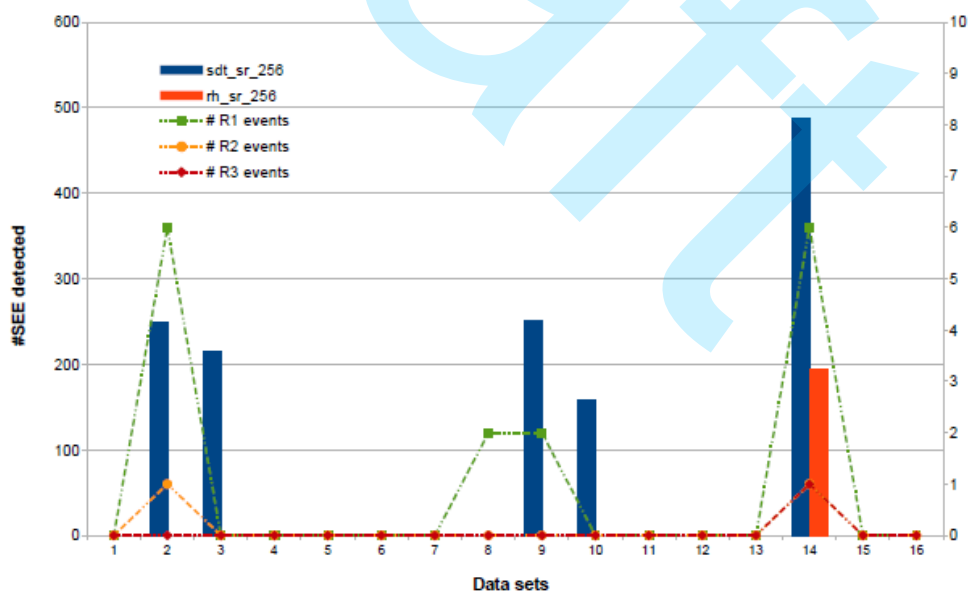

Figure 9: The NANOSATC-BR1 SEE tolerance comparison of two shift-registers (256 stages, 8 inverters) (Medeiros et al., 2014; Noval et al., 2016).

Since the rad-hard cells developed by SMDH were able to be properly tested in space environment, successfully withstanding the space radiation during events R1 and R2 in the beginning of September (the first peaks shown in Figure 10), the next step to characterize the cells was to identify when exactly the rad-hard cells started to demonstrate errors and malfunctions during the R3 event. The solar energetic protons detected by GOES-15 satellite during September 2014 were used in order to analyze and quantify the energy levels measured during the specific R3 occurrence which generated cells errors; therefore, the tolerance of the customized cells was properly estimated. This means that, in the higher peak observed in the graph of Figure 10, the cells developed by SMDH were properly tested in a R3 event environment, demonstrating some tolerance to space weather radiation effects. However, some errors and malfunctions started to occur right after such peak, observed on September 12<sup>th</sup>. The fluency of Solar Energetic Protons – SEPs (Medeiros et al., 2014) during September 2014 at different levels of energy is also demonstrated in Figure 11. During the first two weeks of the month, SEPs with energies above 100 MeV were reported.

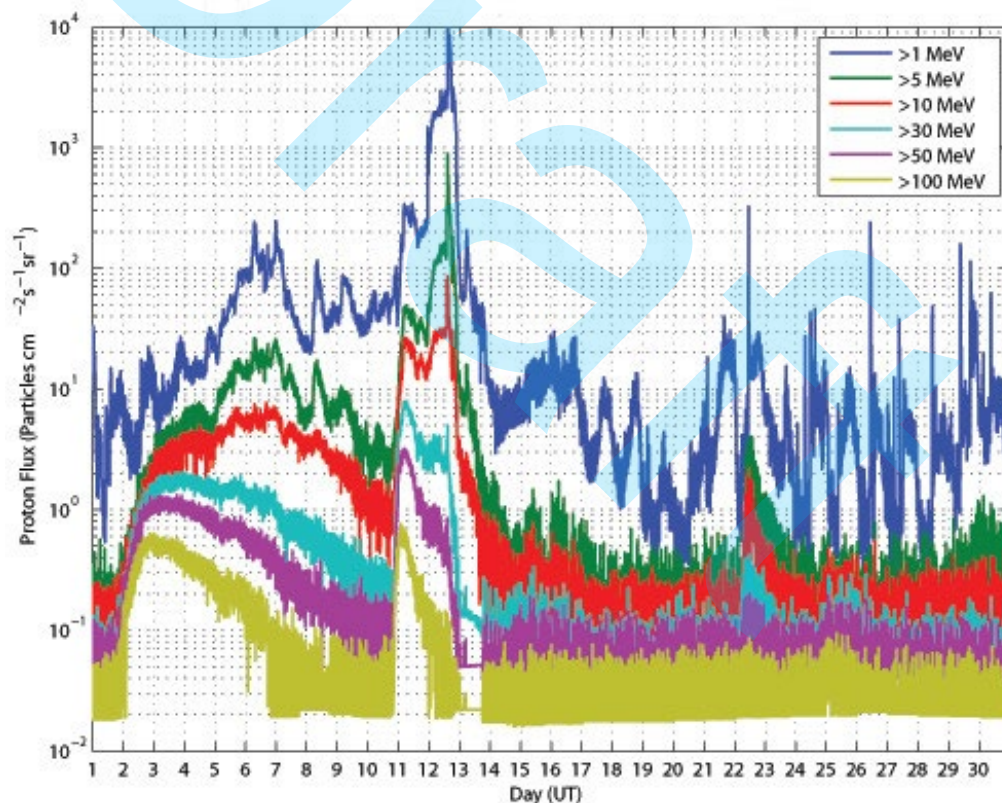

Figure 10: The Solar Energetic Protons - SEPs detected by GOES-15 satellite during September 2014 (Medeiros et al., 2014).

Since ten months after launch, the NANOSATC-BR2 is facing a very challenging situation: it is locked in safe mode, sending the same frame repeatedly. This situation has begun when the CubeSat was right in the border of South Atlantic Magnetic Anomaly, in the same weekend that other small satellites presented malfunctions, indicating a possible radiation effect. One example of this is the JY1Sat, which has stopped transmitting on the same day that the NANOSATC-BR2 became locked in its current situation. The JY1Sat failure has been detected with the support of amateur radio network, which has notified the NANOSATC-BR Program's members about the severe impacts that the space weather's conditions may have caused to small satellites during the beginning of May, 2021. The Ground Station at Santa Maria receives the same data after every one minute, indicating that the OBC (On-Board Computer) has been probably affected by an intense emission of X-Rays, occurred between late April, 2021 and early May, 2021. The frozen frames received are illustrated by Figure 11:



```
[Tue Jan 11 11:39:44 GMT-03:00 2022]
FM: NCBR2 -0 TO: EARTH -0 FCS: GOOD
FF FF 27 D4 60 06 89 E7 00 7D 20 68 00 42 00 05 00 00 00 38 01 8F 03 B5 00 04 00 05 00 87 01 F2 01 00 01 00

[Tue Jan 11 11:40:44 GMT-03:00 2022]
FM: NCBR2 -0 TO: EARTH -0 FCS: GOOD
FF FF 27 D4 60 06 89 E7 00 7D 20 68 00 42 00 05 00 00 00 38 01 8F 03 B5 00 04 00 05 00 87 01 F2 01 00 01 00

[Tue Jan 11 11:41:44 GMT-03:00 2022]
FM: NCBR2 -0 TO: EARTH -0 FCS: GOOD
FF FF 27 D4 60 06 89 E7 00 7D 20 68 00 42 00 05 00 00 00 38 01 8F 03 B5 00 04 00 05 00 87 01 F2 01 00 01 00

[Tue Jan 11 11:42:44 GMT-03:00 2022]
FM: NCBR2 -0 TO: EARTH -0 FCS: GOOD
FF FF 27 D4 60 06 89 E7 00 7D 20 68 00 42 00 05 00 00 00 38 01 8F 03 B5 00 04 00 05 00 87 01 F2 01 00 01 00

[Tue Jan 11 11:43:44 GMT-03:00 2022]
FM: NCBR2 -0 TO: EARTH -0 FCS: GOOD
FF FF 27 D4 60 06 89 E7 00 7D 20 68 00 42 00 05 00 00 00 38 01 8F 03 B5 00 04 00 05 00 87 01 F2 01 00 01 00
```

Figure 11: Frozen Frames (5) received on January 11, 2022. The data locked is sent every minute.

Several corrective measures are being taken throughout the last months with the objective of changing this situation, such as: debugging the on-board software, sending telecommands for resetting the power cycle of the satellite, engineering model testing in various scenarios, as well as continuous contact with the amateur radio network in order to monitor the satellite's telemetry in different locations worldwide.

Such situation is common in CubeSat-based Science missions using COTS – Commercial off-the-shelf components, since there are not many redundancies designed for space applications in these products. Since the NANOSATC-BR2 passed successfully through all the rigorous tests conducted at LIT – Integration and Tests Laboratory, the authors strongly believe that its failure occurred due to severe space



weather's conditions. It is also relevant to mention that the study and solution analysis of this problem also contributes to capacity building development, main objective of the NANOSAT-BR CubeSat program.

### **NANOSATC-BR Program: Capacity Building through INPE's Ground Station at Santa Maria**

The main goal of the INPE-UFSM's NANOSATC-BR, CubeSats Development Program is to perform a specialized human resource capacity building program based on the training of UFSM's undergraduate students and professionals, through science, technological and innovation initiation at INPE/MCTI, in the main areas of Engineering, Computer Sciences and Physics. The program also performs the training of INPE's graduate students through master and doctorate programs in Engineering and Technology of Space Systems and in Space Geophysics.

Currently, one of the main tools for accomplishing this task is the INPE's Ground Station at Santa Maria, which contains UHF/VHF antennae for both receiving telemetry and sending telecommands, as well as a S – Band dish antenna for downlink in this specific band. The antennae are positioned in the roof of the Southern Space Coordination of the National Institute for Space Research – COESU/INPE – MCTI's building (Fig.12):



Figure 12: VHF and UHF Antennae positioned in the Roof of the Southern Space Coordination of the National Institute for Space Research – COESU/INPE – MCTI, in Santa Maria, RS.

Students track satellites, control the antennae pointing and perform uplink and downlink communications through several and interrelated software installed in the computers located at the Ground Station Control Room of LITN – Nanosatellites Integration and Tests Laboratory (Fig.13):





Figure 13: Computers of the Santa Maria Ground Station Control Room (GS), located at the Nanosatellites Integration and Tests Laboratory (LITN), integrated at COESU/INPE - MCTI, in Santa Maria, RS.

Initially, students use the Orbitron Freeware – a free tool for obtaining the exact position of a given satellite in space, with the objective of predicting the orbit of a spacecraft and the exact time in which the tracking process will be successful over the city of Santa Maria, RS. The software also provides important information regarding the tracking process, such as the exact Azimuth/Elevation degree values of the passage, the possibility of settling the uplink/downlink frequencies manually, and also providing simulations for future passages of a specific CubeSat over Santa Maria, RS. The Orbitron interface, showing the NANOSATC-BR2 about to fly over Brazil is in Fig.14:

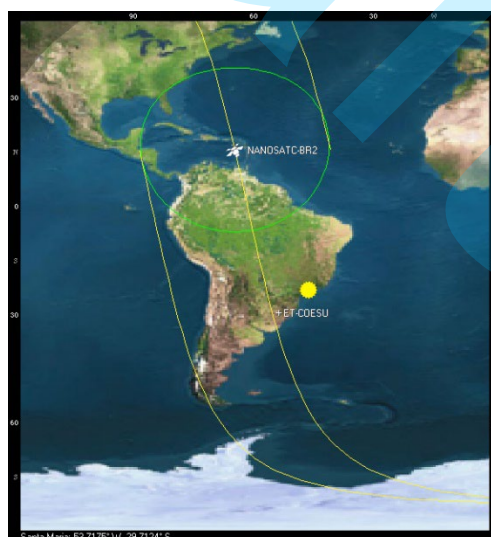

Figure 14: NANOSATC-BR2 CubeSat about to fly over Brazil, as shown in the interface of the Orbitron software.

Once the satellite is correctly tracked and its position can be predicted in real time, the green circle around the spacecraft, also exposed by Fig.14 indicates the area in which the satellite signal can be reached. Then, the Ground Station transceiver unit is settled in the correct uplink/downlink frequencies and modes for both receiving telemetry and sending telecommands, whereas the fine adjustment of the radio is manually performed by rotating the dial knob. A description of the whole process of NANOSATC-BR2's tracking, from the satellite to the mission's stakeholders is described by a block diagram, represented by Figure 15:

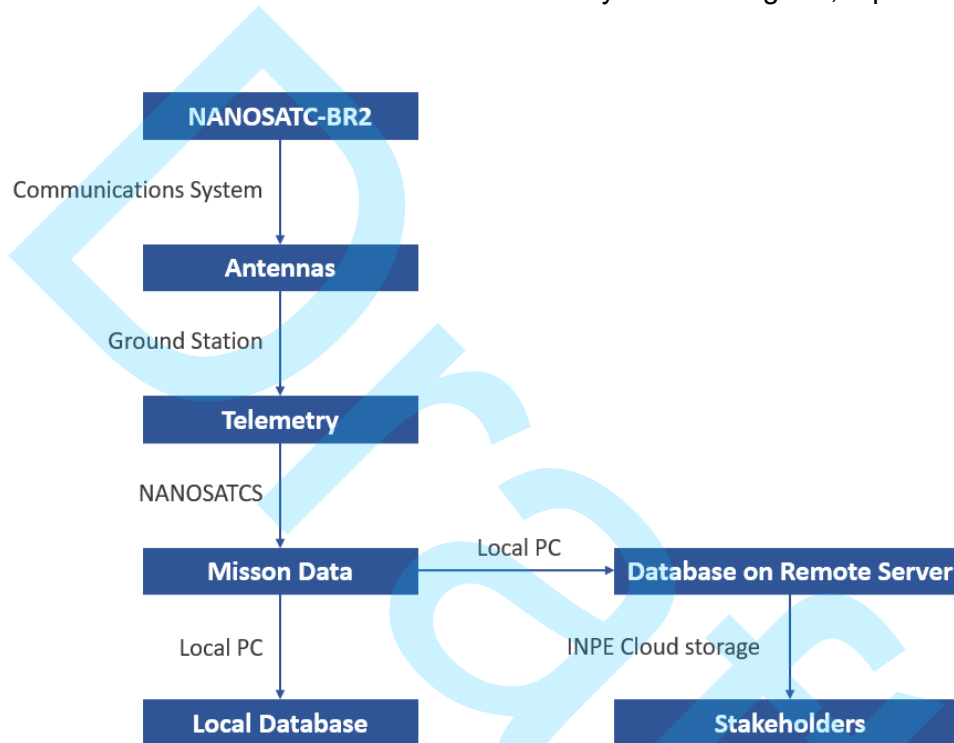

Figure 15: Block Diagram of NANOSATC-BR2's Data Acquisition.

### **NANOSATC-BR program: Support to other CubeSat scientific missions through INPE's Ground Station at Santa Maria and future work**

Students have important weight on the Project technical and scientific branches, since their tasks in the tracking process will provide important scientific and technological data for space missions, such as temperature values of CubeSats in space, battery voltage, parameters of magnetometers, etc. The NANOSATC-BR Program has offered support for several CubeSat Missions worldwide since its beginning, being the most recent case, the ITASAT-1 Mission, a 6U CubeSat launched on December, 2018 which

was successfully tracked by the NANOSATC-BR Program's members throughout its whole mission. On December, 2021 the satellite completed three years operational in orbit, with the NANOSATC-BR program members completing the anniversary Flight Plan from this CubeSat in space successfully.

For the near future, it is expected an increase in the number Brazilian nanosatellites as well as of operators of the INPE's Ground Station at Santa Maria, expanding this way the tracking possibility of space missions. These operators may contribute for improving the tracking operations, and perform hardware and software upgrades. An example of a near future development is the tracking and telemetry process automation, which are currently dependent on on-site staff to operate satellites. Future work regarding the tracking of satellites in the S-Band is also expected, increasing this way the number of space missions which the NANOSATC-BR Program will contribute to.

## **CONCLUSION**

Since it provides to young people the possibility of working and contributing to space missions from all around the world, the Brazilian: INPE-UFSM, NANOSATC-BR, CubeSat Development Program, proved to be an excellent tool for developing a new generation of Scientists, Engineers and Researchers in Aerospace Technologies in Brazil.

Students coming from several Engineering courses (Aerospace, Electrical, Mechanical, among others) are nowadays contributing for the success of scientific space missions, being exposed to Ground Station's technology.

It is expected an increase in the Brazilian Government Agencies support with more investments for the development of Space Technology and new university initiatives. Examples such as the Brazilian INPE-UFSM NANOSATC-BR, CubeSats Development Program, with its two nanosatellites (the NANOSATC-BR1 & NANOSATC-BR2 Projects) should be taken into account in this sense.

## **ACKNOWLEDGMENTS**

The authors would like to thank the support from AEB – Brazilian Space Agency for the whole Project, and also the scholarships received from the National Council for Scientific and Technological Development – CNPq with grant numbers: 300459/2021-1 and 301628/2021-1 for the Project: “Communication and Control Systems for Nanosatellites”, which contributed for the development of this study. N. J. Schuch thanks CNPq for the fellowship under the number 300886/2016-0. Also, this study was financed in part by the Coordination for the Improvement of Higher Education Personnel (CAPES) – Finance Code 001. D.P.de

Almeida and C.L.G. Batista would like to thank CAPES through processes 88882.444544/2019-01 and 88882.444451/2019-01. The authors would also like to thank the FATEC (Science and Technology Support Foundation) for funding this research with grant number 3.07.0070 (100597).

## REFERENCES

Almeida, D. P, "Conops2M: Concept of Operations Modelling for CubeSat based Space Mission. – Master Dissertation of the Graduate Course in Engineering and Space Technology - Instituto Nacional de Pesquisas Espaciais, São José dos Campos, SP, Brazil, 2021 77pp.

Asencio JCR. 2021. NANOSATC-BR2 Assembly, Integration and Test - AIT Report. In: Internal Technical Presentation at Instituto Nacional de Pesquisas Espaciais, São José dos Campos, SP, Brazil,.

Bürger, E. E, "Proposta de método para AIT de pico e nanossatélites", Master Dissertation of the Graduate Course in Engineering and Space Technology/Space Systems Engineering and Management, Instituto Nacional de Pesquisas Espaciais, São José dos Campo, SP, Brazil, 2014.283 pp.

ESA. "ECSS-E-ST-10-03C", European Cooperation for Space Standardization, 2012. European Space Agency. Available at: <<https://ecss.nl/standard/ecss-e-st-10-03c-rev-1-testing-31-may-2022/>>. Accessed on: June 3<sup>rd</sup>, 2021.

GK Launch Services. 2021. Footage from the #Soyuz-2.1a launch. Available at: <[https://twitter.com/gk\\_launch/status/1373921583643959297](https://twitter.com/gk_launch/status/1373921583643959297)>. Accessed on: July 9<sup>th</sup>, 2021.

Heitzler, J. R., "The Future of the South Atlantic Anomaly and implications for radiation damage in space". Journal of Atmospheric and Solar-Terrestrial Physics, pp.1701-1708. 2002.

INPE. 2018. Missão do NanosatC-Br1. NANOSATC-BR1. Instituto Nacional de Pesquisas Espaciais, São José dos Campos, SP, Brazil Available at:<[http://www.inpe.br/crs/nanosat/missao/nanosatc\\_br1.php](http://www.inpe.br/crs/nanosat/missao/nanosatc_br1.php)>. Accessed on: July 9<sup>th</sup>, 2021.

Medeiros, L. ; Zaffari, C. A. ; Noval, J. J. S. ; Teixeira, L. Martins, J. B. S. "Using the NANOSATC-BR1 to evaluate the effects of space radiation incidence on a radiation hardened ASIC". In: 1st IAA Latin American CubeSat Workshop, 2014, Brasília, DF, Brazil. Conference Proceedings 1st IAA, 2014.

NANOSATC-BR PROGRAM, "Environmental Test Plan", Technical Document, Universidade Federal de Santa Maria, RS, Brazil, 2020.

Noval, J. J. S. ; Medeiros, L. ; Martins, J. B. S. ; Schuch, N. J. ; Durao, O. S. C. ; Machado, R. "Design considerations for Radiation Hardened ASIC used as technological payload in NANOSATC-BR1". In: 2nd IAA Latin American CubeSat Workshop, 2016, Florianópolis, SC, Brazil. Conference Proceedings 2nd IAA, 2016.

Schuch NJ, Durão OSC, da Silva MR, Mattiello-Francisco F, Martins JBS, Legg AP, da Silva AL & Bürger EE. 2019a. The NANOSATC-BR, CubeSat Development Program – A Joint CubeSat Program Developed by UFSM and INPE/MCTIC – Space Geophysics Mission Payloads and First Results. *Brazilian Journal of Geophysics*, 37(1):95-103.

Schuch NJ, Marques RP, Pedroso FS, Mânica TR, da Costa LZ, Moro J, Legg AP, Martins JBS, da Silva AL, Bürger EE, Durão OSC, Mattiello-Francisco F, da Silva MR & Mendes O. 2019b. Gestão de Competências e Futuro do Programa NANOSATC-BR, Desenvolvimento de CubeSats, Parceria UFSM – INPE/MCTIC. In: 2 Congresso Aeroespacial Brasileiro, 2019, Santa Maria, RS, Brazil.

The CubeSat Program. 2014. CubeSat Design Specification (CDS) Rev. 13. Cal Poly SLO. California Polytechnic State University, San Luis Obispo. Available at: <[http://cubesat.org/www.cubesat.org/images/developers/cds\\_rev13\\_final2.pdf](http://cubesat.org/www.cubesat.org/images/developers/cds_rev13_final2.pdf)>. Accessed on: July 9<sup>th</sup>, 2021. 42 pp.

**Schuch, N. J.:** program and project manager. students training and coordination;

**Marques, R.P.:** reviewer of paper, satellite tracking, operations;

**Ian Gabriel Souza Lanza:** Reviewer of Paper, Satellite Tracking, Operations, telemetry and telecommand data compilation.

**Pedroso, F.S.:** review;

**Mantovani, L.Q.:** satellite AIT campaign, review;

**Rockenbach, M.:** review;

**Batista, C.L.G.:** satellite AIT campaign, operations, review;

**Almeida, D.P.:** satellite AIT campaign, CONOPs planning;

**Mattiello-Francisco, F.:** training and coordination of INPE graduate students involved in the project;

**Durão, O.S.C.:** review;

**Martins, J.B.S.:** review, payload development;

**Legg, A.P.:** reviewer of paper, satellite tracking, operations;

**da Silva, A.L.:** training and coordination of the students involved in the project;

**Moro, J.:** review;

**Bürger, E.E.:** project engineering coordination at UFSM, satellite AIT, satellite operations, training and coordination of UFSM students.